

Box (Side View)

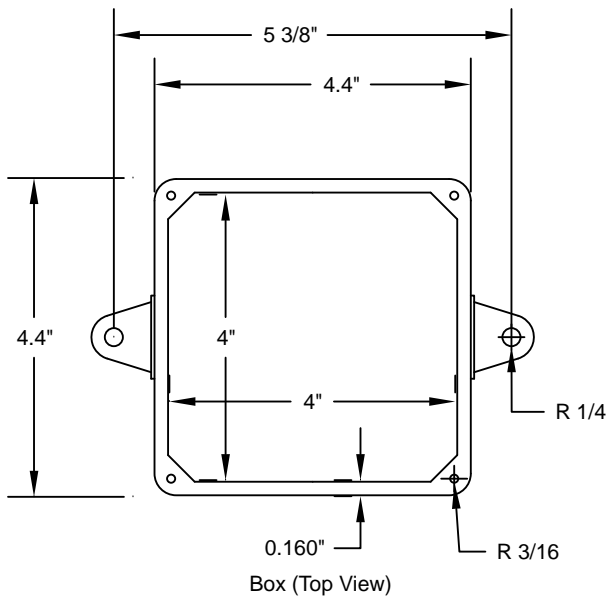

Box (Top View)

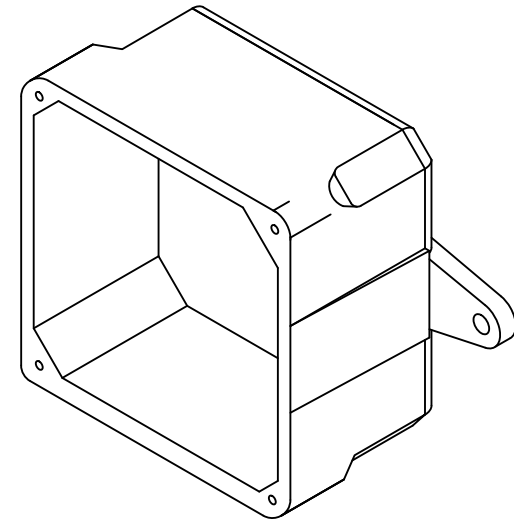
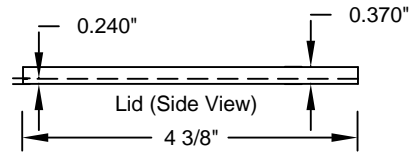

Lid (Side View)

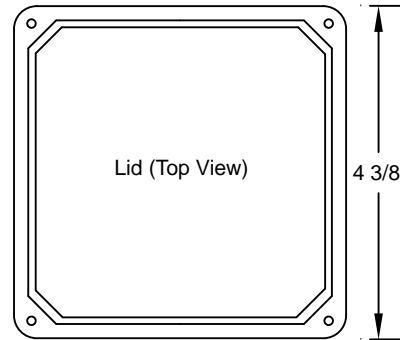

Lid (Top View)

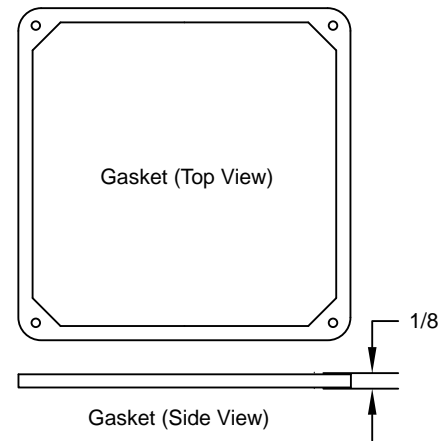

Gasket (Top View)

Gasket (Side View)

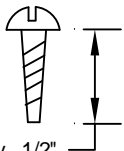

8 by 1/2"

UL Listed
 Marine Listed
 UL File # E205935 (QCUP)
 UL Control # 92CM
 Material is Rigid PVC
 91.8 cu in Volume (1505 cu cm)
 Screws are Zinc Plated Steel
 Gasket is neoprene



CANTEX
 INC.
 Fort Worth, TEXAS

Junction Box 4 x 4 x 6

Drawn By: Scott Frank | Date: 8-12-2008 | 5133707